



**MITSUBISHI
ELECTRIC**

Changes for the Better

ESCALATORS

SERIES **Z**

for a greener tomorrow



Quality
inMotion 

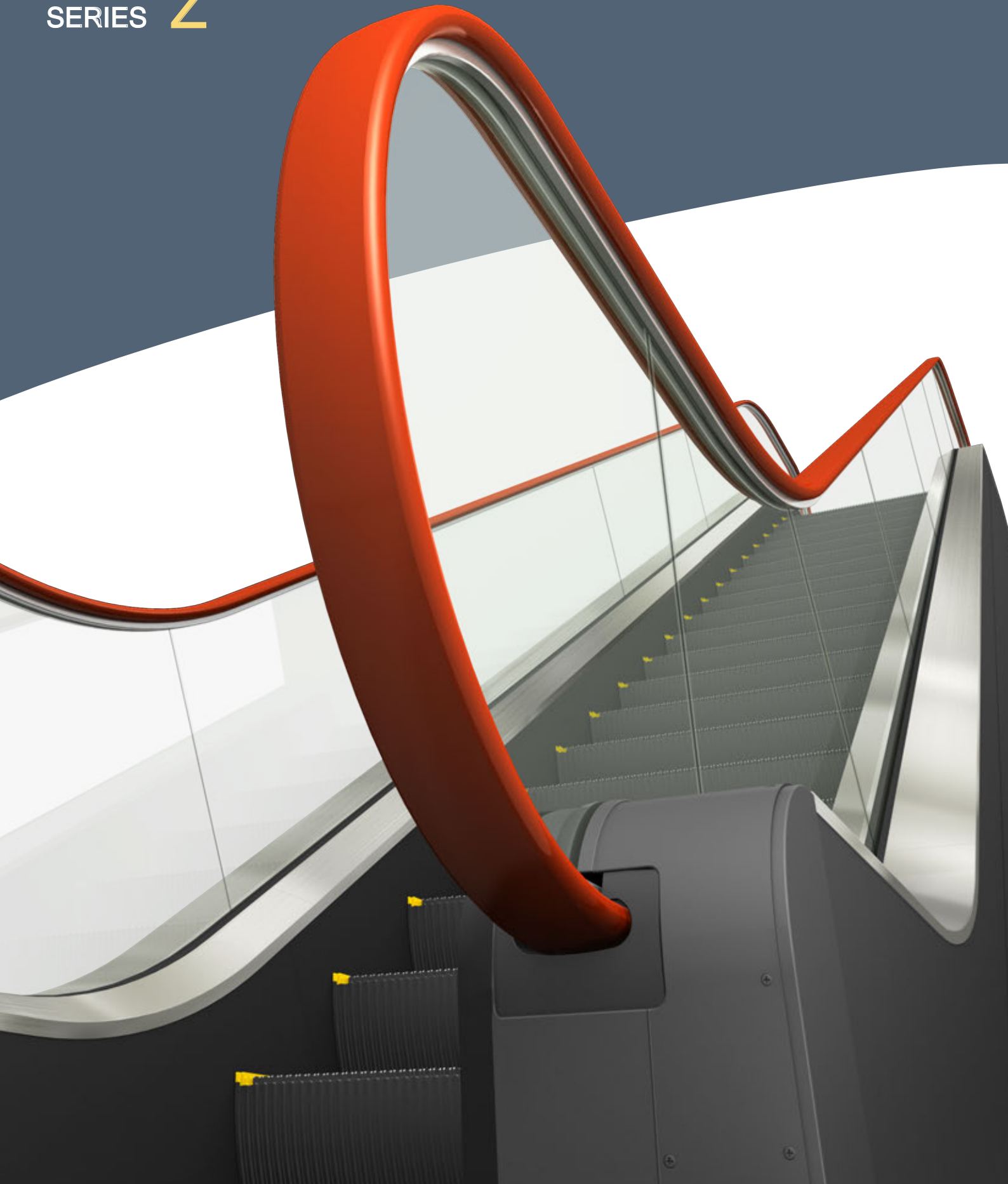

Our new escalator **Series Z** offers more than just a way to **carry passengers**

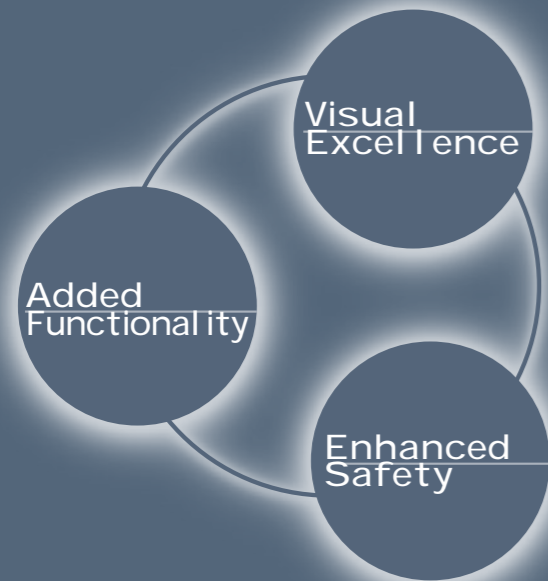

Aesthetic elegance and flexibility are concepts expected more than ever. Our new escalator Series Z comes in a simple, yet sophisticated design, offering the utmost in flexibility to blend with any building decor. Our years of experience in **safety-oriented** production, based on a strong belief in the importance of safety, have led to a variety of safety features, as well as a wide range of **value-added functions** that help you customize your own escalators, creating uniqueness in and incomparable value for your building properties.

The Mitsubishi Electric Series Z Escalator fulfills and indeed exceeds customer expectations, through the **collaboration and utmost performance** of visual, functional and safety elements.

Feel the elegance, high quality and comfort of the **Series Z** in your building.

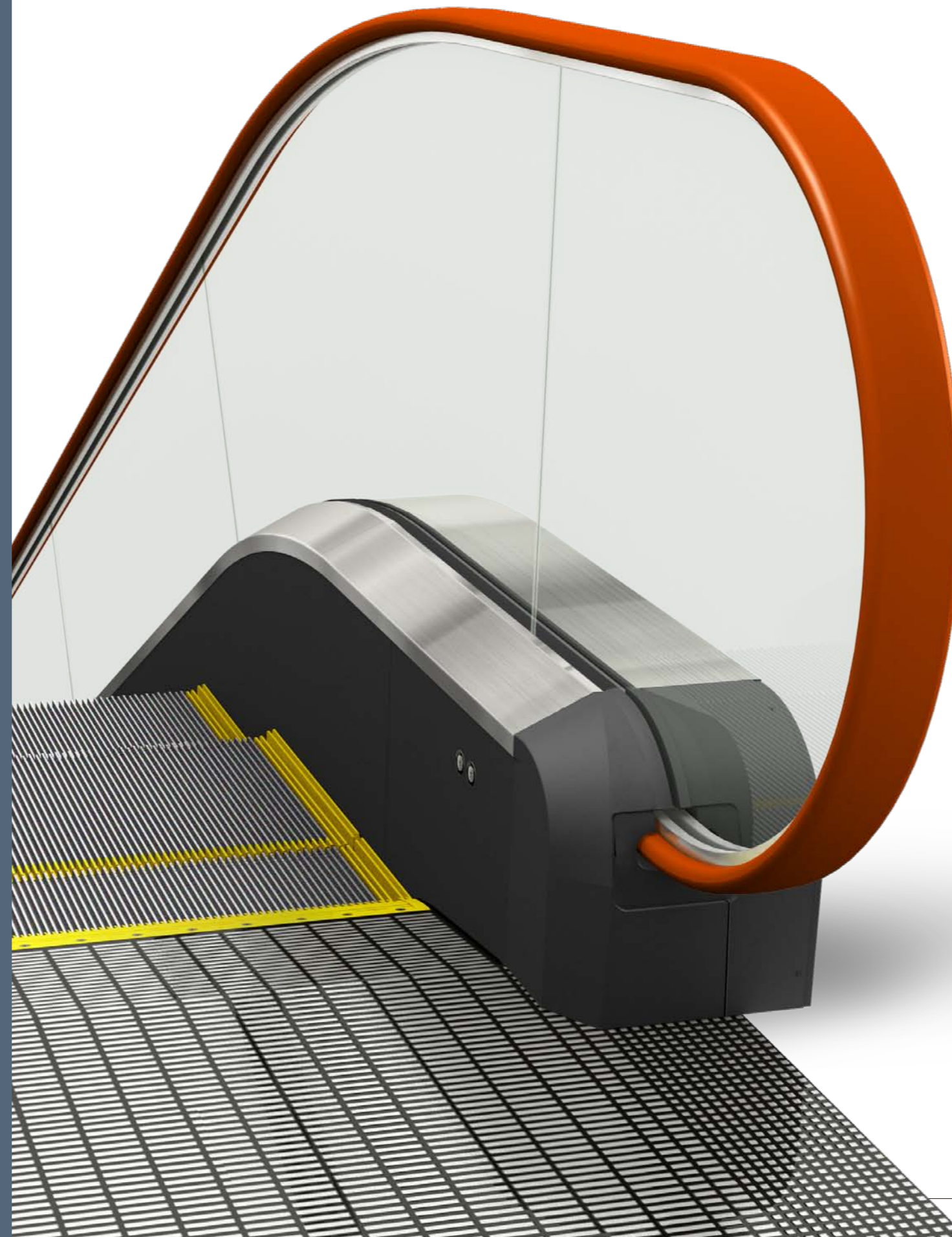

Models for various scenes 3-4

STANDARD

Visual Excellence

Features that blend with architecture

5-6

Brings elegance and sophistication to your building

STANDARD

Enhanced Safety

Safety-oriented and customer-friendly designs

7-8

Offers enhanced safety and comfort

OPTIONAL

Added Functionality

Versatile functions to select from

9-10

Enables customization for uniqueness

OPTIONAL

Automatic Operation / Variable-Speed Operation

11

Standard specifications

12

Cautions for outdoor use / Remote monitoring

13

Escalators in the graphics are based on the Japan Code, with optional Fluoropolymer Coating on Skirt Guard.



Models for various scenes

GLASS PANEL ZS



The simplest of designs blends with any building decor, adding a quiet, sophisticated air to your architecture.



Dimensions

Step width

Type S600 : 604mm
Type S800 : 804mm
Type S1000: 1004mm

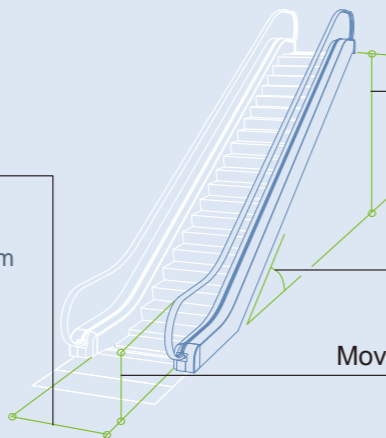

Rise
30° : max 7000mm*1
35° : max 6000mm

Inclination
30° or 35°

Moving Handrail height
950mm or 1000mm*2

*1: Please refer to the enclosed leaflet for rises exceeding 7000mm.

*2: Please contact your local Mitsubishi Electric sales agent for 1000mm-high Moving Handrails.

Escalators in the graphics are based on the Japan Code, with optional Fluoropolymer Coating on Skirt Guard.

ZL GLASS PANEL WITH UNDER-HANDRAIL LIGHTING

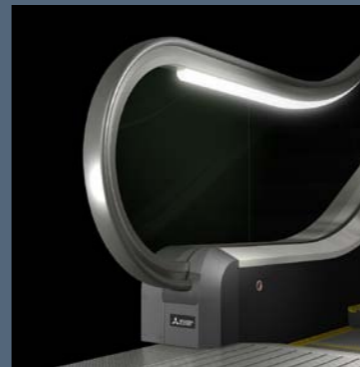

Lighting under the Moving Handrails creates an effect of warm, glowing elegance.



STAINLESS PANEL ZP

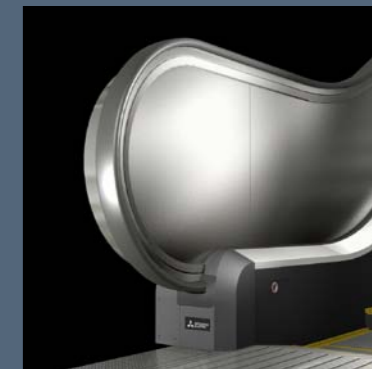

Stainless steel panel that exudes strength and durability.

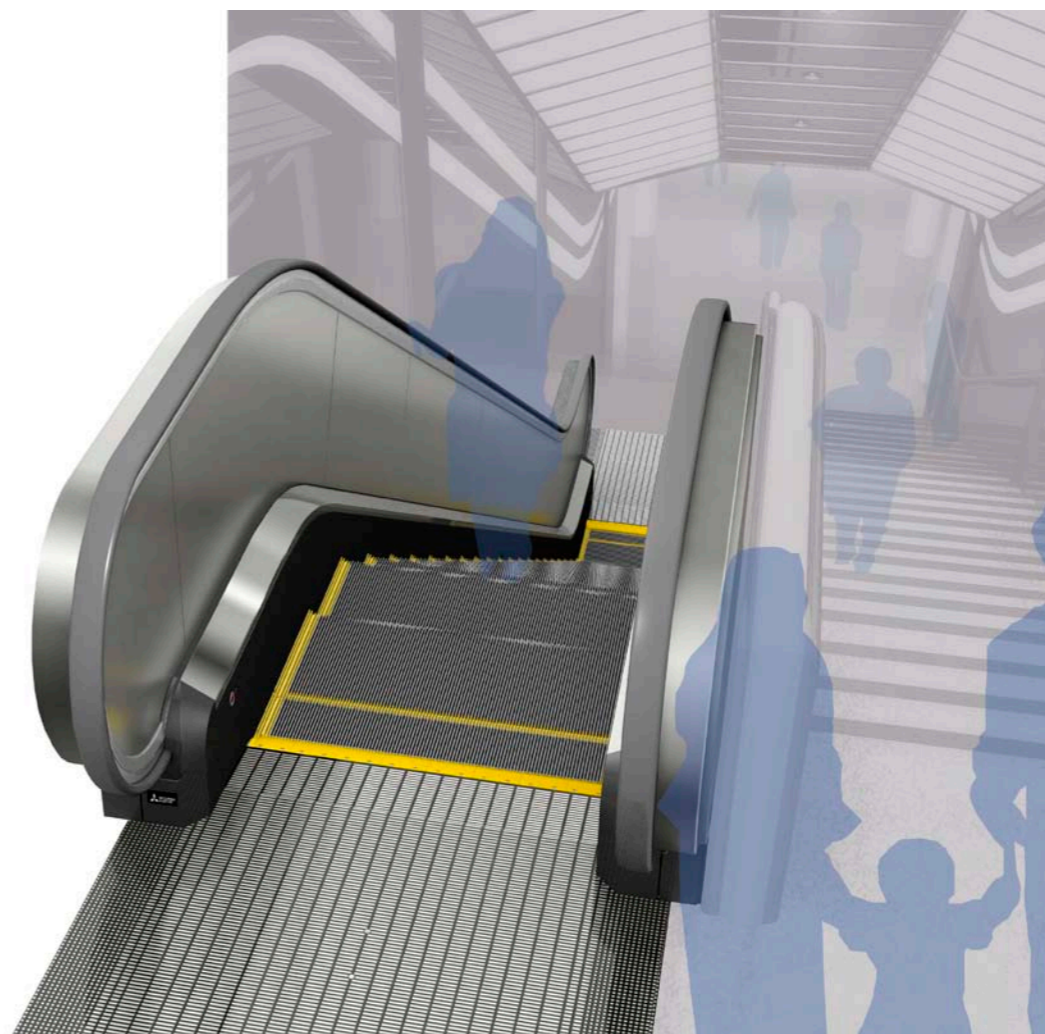

Visual Excellence

Features that blend with architecture

Our new Escalator Series Z serves passengers naturally and peacefully.



Rounded Handrail Inlet Cap

Our rounded Handrail Inlet Cap streamlines with the Moving Handrails, lending a silent elegance to the boarding and landing areas.

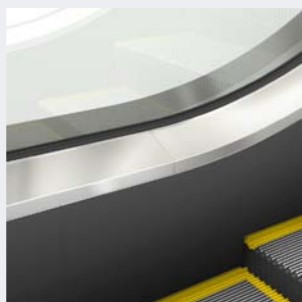

Screw-free Inner Deck

Removing screws from the Inner Deck side face not only presents an even softer, more simple look, but also removes the danger of passengers snagging their clothes.



Clearly-contrasted Floor Plate

For improved visibility and smoother passenger flows, extended areas from the Moving Handrails feature different pattern with a clear contrast.



Space Saving

Shortening the Truss by 205mm* requires less escalator installation space and increases freedom in building layout.

* Compared with the Mitsubishi Electric Series J Escalator (for EN115), except for VVVF control.

Colors available for Moving Handrails (rubber)

Only "No. 0001 Black" is standard. Other colors are optional.



Handrail colors for outdoor use are different from these shown on this page. Please contact your local Mitsubishi Electric sales agent for details. Handrail colors shown in photos may differ slightly from the actual colors on products.

Moving Handrail

Screw-free Inner Deck

Handrail Inlet Cap

Floor Plate

Escalators in the graphics are based on the Japan Code, with optional Fluoropolymer Coating on Skirt Guard.





Safety-oriented and customer-friendly designs

Enhanced
Safety

You'll truly feel the difference.
Safety and ride comfort are
the ultimate goals for Mitsubishi.

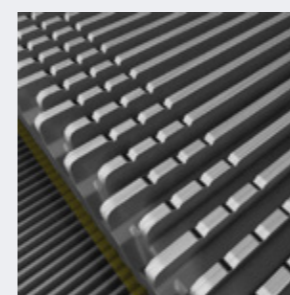

Step with Anti-Slip Grooves

Grooves along the corner edge of each step improve anti-slip performance and the visibility of each step for further passenger safety.

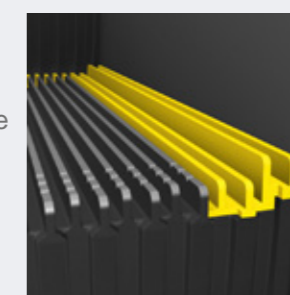

Tiered Demarcation Line

Demarcations along both sides of a step are raised from the step surface, thereby preventing passengers from getting too close to the skirt guards and preventing clothes from getting caught between a step and skirt guard.

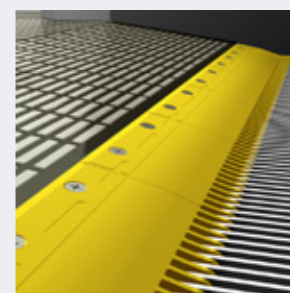

Comb with Smaller Angle

Mitsubishi recognizes how critical the Comb teeth angle is: even a small gap between the Comb and Step can result in a serious accident. Putting our years of experience and research to full use, we have made the angle the smallest it can be (10° to the horizontal) to keep passengers and items such as baggage from stumbling or getting caught between the Comb and Step.

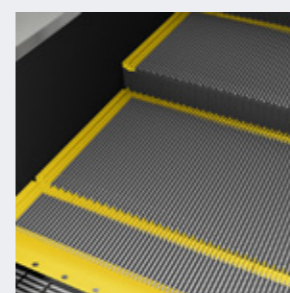

Brighter Demarcation Color

Attention to the smallest details is the chief theme of Mitsubishi's safety criteria, and the color of the Demarcation Line is no exception. The yellow Step and Comb Demarcation Line comes as standard and its brightness has been improved to provide better visibility of the Step, Comb and Floor Plate than in our other models.

Added
Functionality

Versatile functions to select from

A wide range of optional features help you customize your own escalators, contributing to increased property value.

Lighting*¹

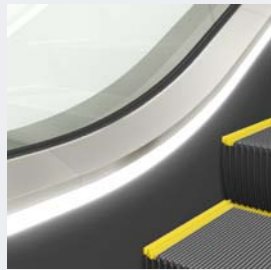

Skirt Guard Lighting²

Lighting can be provided along the entire length of the skirt guard, lighting up the step demarcation for both visual effect and passenger safety.

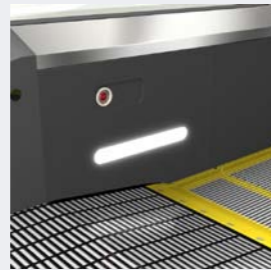

Comb Light

Lighting provided at Comb level increases illumination, which further improves passenger safety around the Step as well as visual effect.

Directional Indicators at boarding and landing areas*¹ *³



Handrail Inlet Cap LED Indicator

LED lamps form an arrow to indicate the escalator's traveling direction for boarding, or a No-Entry sign at the landing areas.

Warning System*³

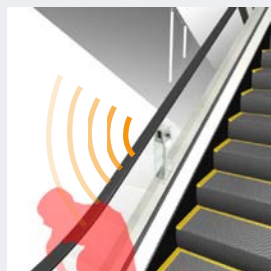

Outer Deck Sensor⁴

When a sensor on the Outer Deck detects a passenger leaning outside the Moving Handrail, a buzzer and voice sound to alert the passenger to the potential danger of bumping against an adjacent escalator or wall.



Inlet Sensor

This sensor keeps any passengers or foreign objects away from the Handrail Inlet, a warning buzzer and voice sounding when a person or object comes close to the Inlet.

More Options



Floor Name

Floor names can be engraved on each floor plate to help passengers quickly identify which floor they are on.



Fluoropolymer Coating on Skirt Guard*⁵

The Skirt Guard can be coated with a friction-reducing resin to reduce the chance of passengers stumbling when their shoes come in contact with the Skirt Guard.



*1: For available combinations of optional features, please refer to the Specifications on the enclosed leaflet.
 *2: Not applicable to semi-outdoor and outdoor use.
 *3: Not applicable to outdoor use.
 *4: Not applicable to model ZP.
 *5: Standard feature in countries where EN115 applies.

A Automatic Operation / V Variable-Speed Operation

S Standard specifications

Inverter-controlled Automatic and Variable-Speed Operations

VVVF Control (Variable Voltage, Variable Frequency)

Our newly-developed, innovative escalator inverter enables a unique way of controlling the escalator speed in Automatic and Variable-Speed Operations. In Variable-Speed Operation, the escalator speed can be selected according to the frequency of use, number of passengers, and more. Please contact your local Mitsubishi Electric sales agent for VVVF control.

Post-Free Automatic Operation

Sensor Posts are no longer needed, as the sensors embedded in the Handrail Inlet Cap detect passengers and control Automatic Operation. The escalator operates at a low speed in stand-by, and gradually increases speed to the rated speed after detecting a passenger approaching the boarding area.

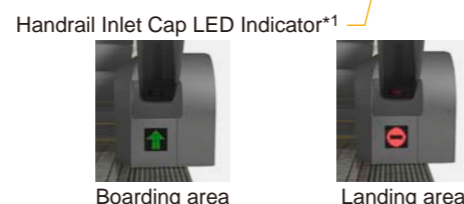
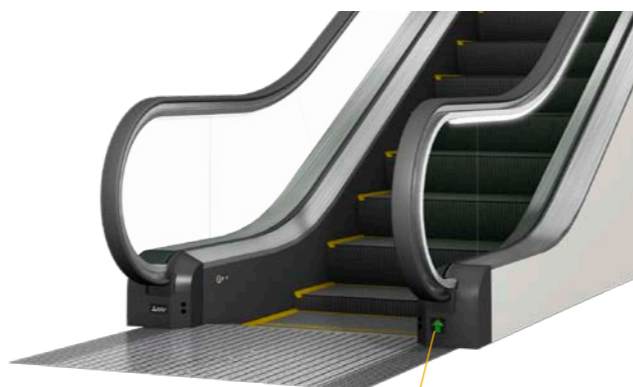

Escalators operate at a low speed in stand-by.

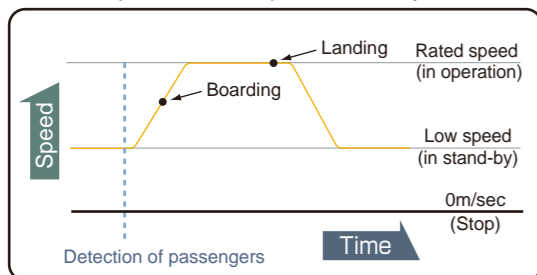

*1: Handrail Inlet Cap LED Indicator:
 - Remains the same regardless of the operating speed during Automatic Operation.
 - A separate option, and not included in Post-Free Automatic Operation.

Automatic Operation with Posts



Sensor Posts located on both sides of the landing and boarding areas incorporate traditional Beam Sensors, with or without^{*2} Directional Indicators allowing or denying passenger entry. Control by AC1, instead of inverter control, can be adopted in Automatic Operation with Posts, whereby the escalator remains stationary on stand-by.

*2: For escalators stationary in stand-by, Directional Indicators are required in countries where EN115 applies.

Variable-Speed Operation

Two more speeds^{*3}, not exceeding the rated speed, can be added to your escalator to make it possible to operate at three different speeds. The speeds are selected using a key switch, set at Low or Middle for the added speeds and High for the rated speed, thereby allowing you to select the best speed for each set of traffic conditions.



*3: For an escalator with a rated speed of 0.6m/sec, for example, additional speeds of 0.5m/sec and 0.3m/sec can be set. For more information, contact your local Mitsubishi Electric sales agent.

Basic specifications

Please refer to the enclosed leaflet for EN115 code or Japan code.

Item	S600	S800	S1000
Models	ZS / ZL / ZP		
Codes	EN115 *1 code / Japan code		
Power supply	AC 3-phase, 50 or 60Hz		
Lighting power supply	AC single-phase, 50 or 60Hz		
Rated speed	0.5m/sec		
Control system	Standard: AC1 Option: VVVF *2		
Theoretical transport capacity *3 (persons/hr)	4500	6750	9000
Inclination	30° / 35°		
Environment	Standard: Indoor Option *4: Semi-outdoor / Outdoor		
Automatic oiler	Standard: None Option: Available		
Min. rise (mm)	30°: 2203	35°: 2527	
Max. rise (mm)	30°: 7000 *5	35°: 6000	
Step width (mm)	604	804	1004
Escalator width (mm)	1150	1350	1550
Between Moving Handrails (mm)	840	1040	1240
Between Skirt Guards (mm)	610	810	1010
Truss width (mm)	1100	1300	1500
Floor opening (mm)	1250	1450	1650

*1: The specifications differ depending on the publication year of the code. Please contact your local Mitsubishi Electric sales agent for details.

*2: Please contact your local Mitsubishi Electric sales agent for VVVF control.

*3: Transport capacity varies depending on actual traffic conditions, so some dimensions and the motor capacity may have to be changed. Please contact your local Mitsubishi Electric sales agent for details if the number of passengers during peak time may equal or exceed the following numbers:

- S600: 525 persons per 10 minutes
- S800: 785 persons or more per 10 minutes
- S1000: 1050 persons per 10 minutes

*4: Please contact your local Mitsubishi Electric sales agent for semi-outdoor and outdoor use. For outdoor use, please refer to "Cautions for outdoor use" on page 13.

*5: Please refer to the enclosed leaflet for rises exceeding 7000mm.

Sections of Balustrade

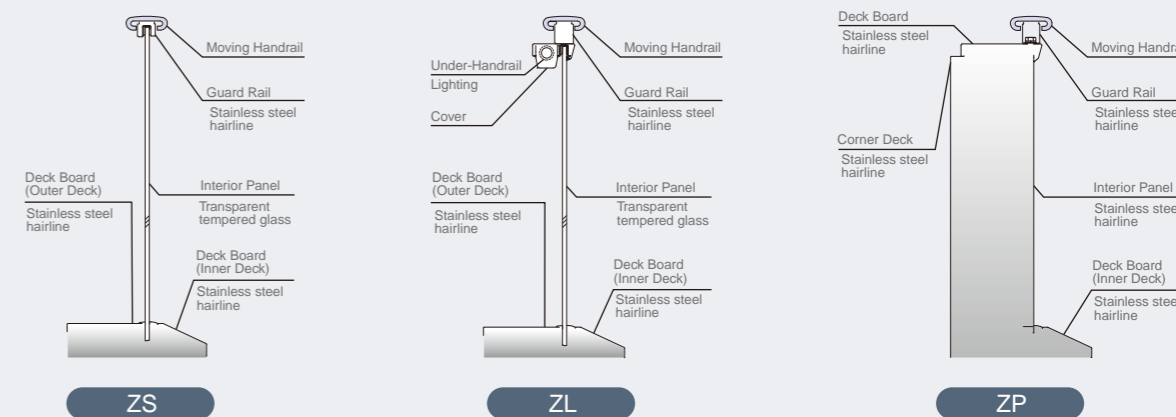

Cautions for outdoor use / Remote monitoring

Cautions for outdoor use

A roof must be provided over outdoor escalators. In rainy weather without a roof, passengers are in great danger of having their umbrellas blown away by the wind or falling down on the slippery Steps. In hot weather, the Moving Handrails and Deck Boards can easily heat up in the sun to a surface temperature exceeding 50°C, causing the unnecessary chance that passengers could get burnt on the overheated elements. In addition, when not covered by a roof, the life and performance of outdoor escalators seriously deteriorate, leading to shorter product life and higher cost for maintenance.

1. How to define outdoor escalators

Escalators are classified into three categories: outdoor, semi-outdoor and indoor. Outdoor escalators are defined as escalators exposed to environmental factors such as wind, rain, snow or direct sunlight.

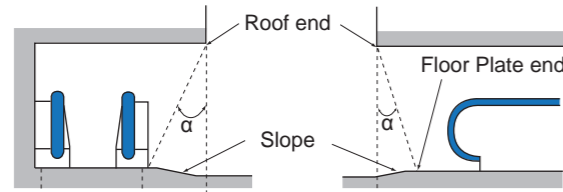

Indoor	$\alpha > 70^\circ$
Semi-outdoor	$70^\circ \geq \alpha \geq 30^\circ$
Outdoor	$\alpha < 30^\circ$

Angle α in the illustration varies depending on the direction in which the escalator is viewed. Check how the angle varies, take the smallest angle, apply it to the table above and determine the escalator type.

2. Environmental requirements for outdoor escalators

Permissible ambient temperature	Minimum	-10°C (special measures are required in cold districts where the ambient temperature can drop below -10°C)
	For escalator operation	0°C ~ less than 35°C
Wind pressure	Escalators must not be exposed to direct wind pressure outside the following ranges: 490N/m ² or less on the windward side, 245N/m ² or less on the leeward side	
Others	Measures are required for escalators installed within a 2-kilometer radius from a shore to protect them from direct exposure to salty wind.	

3. Architectural requirements for outdoor escalators

- Intermediate support beams must be provided.
- The level of the escalator Floor Plate must be higher than the floor finish of the building to minimize the chance of rain or cleaning water running into the escalator truss. Area (B) in the illustrations to the right must be at a slope of at least 10°, and the surface of (A) must be horizontal to minimize the risk of passengers stumbling.
- Drainage must be provided in the entire area marked (C) and covered with grating to keep away drain water.
- The escalator pit must be waterproofed entirely when a whole truss is installed inside the pit. In addition, the upper pit floor must be sloped towards the lower floor to let any water in the pit drain out and down.
- If there is a chance of the lower machine room getting flooded, drainage equipment, such as a drain pump, must be provided to discharge any water.
- Water in the lower pit will contain lubrication oil, so a grease trap should be provided to separate the lubrication oil from the water. The capacity of the grease trap is determined according to the escalator size and maximum amount of expected rainfall.
- Water may drip from the exterior panels of the escalator. Take waterproofing measures for equipment or items under the exterior panels if water is likely to cause problems or accidents.

Detailed floor plan for outdoor escalators

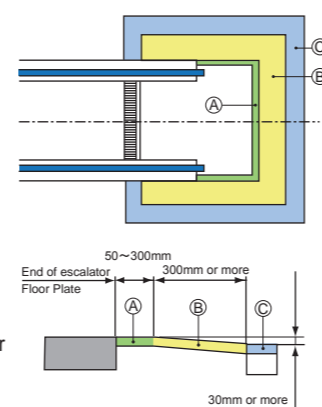

Please contact your local Mitsubishi Electric sales agent for outdoor use.

Remote monitoring OPTIONAL

Mel Eye

Mitsubishi Electric's MelEye is a sophisticated Web-based elevator and escalator monitoring and control*1 system that allows authorized personnel to respond rapidly to changing traffic patterns and other operational conditions. It improves passenger safety and reliability of your building management.

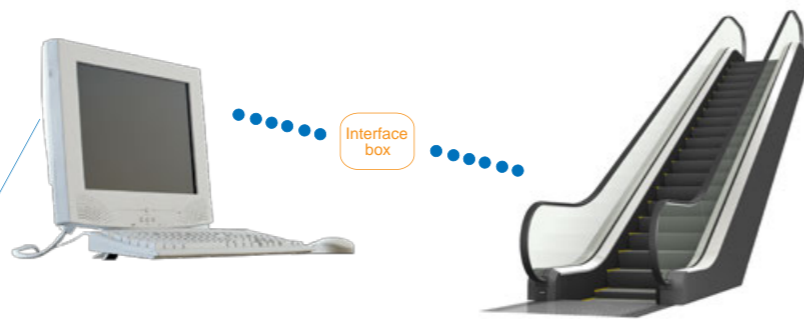
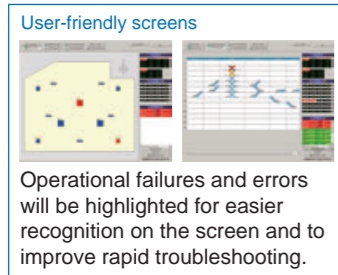

*1: Please note that MelEye is designed for monitoring of escalator operation, not to control the escalators remotely.
*2: Contact your local Mitsubishi Electric sales agent for a brochure or further information.

IMPORTANT INFORMATION

Work not included in the escalator contract

The following items are not included in Mitsubishi Electric's escalator installation work, and the responsibility for carrying them out lies with the building owners or general contractors:

- Building construction and alterations associated with escalator installation
- Provision of intermediate support beams (if required)
- Provision of truss-supporting beams, including mounting plates
- Floor finishing after escalator installation
- Provision of fire-proofing and fire-prevention measures for escalator exterior materials and around escalator installation
- Provision of fire-prevention shutters (if required by local codes or regulations)
- Wiring for the escalator's main drive and lighting, from around the middle portion of the truss to the escalator's Control Unit in the upper truss
- Other wiring and electric conduits
- Provision of convenience outlets in the upper and lower truss
- Outer panel sheathing of truss
- Provision of inspection doors (lockable doors if installed in an environment where anyone could access and open the doors)
- All items for which procurement by building owners is instructed (with wording such as "by owner")

Notes on building work

- Tolerance in distance between supporting beams: +30mm to 0 or 13/8" to 0"
- Flooring around the escalator must not be finished until the escalator is installed
- Flooring within 300mm or 12" of the escalator Floor Plate must not be finished until the Floor Plates are in place
- Sprinkler pipes or wiring for soffit lights, or any other electric conduits for items other than escalator, must not be laid inside the truss
- No walls or other parts of the building structure must be supported on the truss
- Allowable maximum weight of outer sheathing: 20kg/m² or 0.028 psi

Ordering information

Please submit the following information when ordering or requesting escalator quotations:

- Name and address of the building
- Escalator model (ZS or ZL or ZP)
- Escalator type (S1000 or S800 or S600)
- Rise (floor height) and number of floors
- Number of escalators
- Voltage and frequency of the power source for escalator's main drive and lighting
- Optional items required
- Whether or not fire-prevention shutters are required



State-of-the-Art Factories... For the Environment. For Product Quality.

Mitsubishi Electric elevators and escalators are currently operating in approximately 90 countries around the globe. Built placing priority on safety first, our elevators, escalators and building system products are renowned for their excellent efficiency, energy savings and comfort. The technologies and skills cultivated at the Inazawa Works and 13 overseas manufacturing factories are utilized in a global network that provides sales, installation and maintenance in support of maintaining and improving product quality. As a means of contributing to the realization of a sustainable society, we consciously consider the environment in business operations, proactively work to realize a low-carbon, recycling-based society, and promote the preservation of biodiversity.

ISO9001/14001 certification

Mitsubishi Electric Corporation Inazawa Works has acquired ISO 9001 certification from the International Organization for Standardization based on a review of quality management. The plant has also acquired environmental management system standard ISO 14001 certification.

Mitsubishi Elevator Asia Co., Ltd. has acquired ISO 9001 certification from the International Organization for Standardization based on a review of quality management. The plant has also acquired environmental management system standard ISO 14001 certification.



for a greener tomorrow

Eco Changes is the Mitsubishi Electric Group's environmental statement, and expresses the Group's stance on environmental management. Through a wide range of businesses, we are helping contribute to the realization of a sustainable society.

MITSUBISHI ELECTRIC CORPORATION
HEAD OFFICE : TOKYO BLDG., 2-7-3, MARUNOUCHI, CHIYODA-KU, TOKYO 100-8310, JAPAN

Visit our website at:
<http://www.MitsubishiElectric.com/elevator/>

⚠ Safety Tips: Be sure to read the instruction manual fully before using this product.

Revised publication, effective May 2017.
Superseding publication of L-170-6-C74881-J Apr. 2016.
Specifications are subject to change without notice.
Actual products may differ slightly from the graphics in this brochure.

©2006 Mitsubishi Electric Corporation

The Series Z escalator is equipped with various safety devices that provide for safety and reliability.

For Japan Code

For Japan Code



For High Rise

Rise (mm): 7001 - 13000

●...Standard ○...Optional

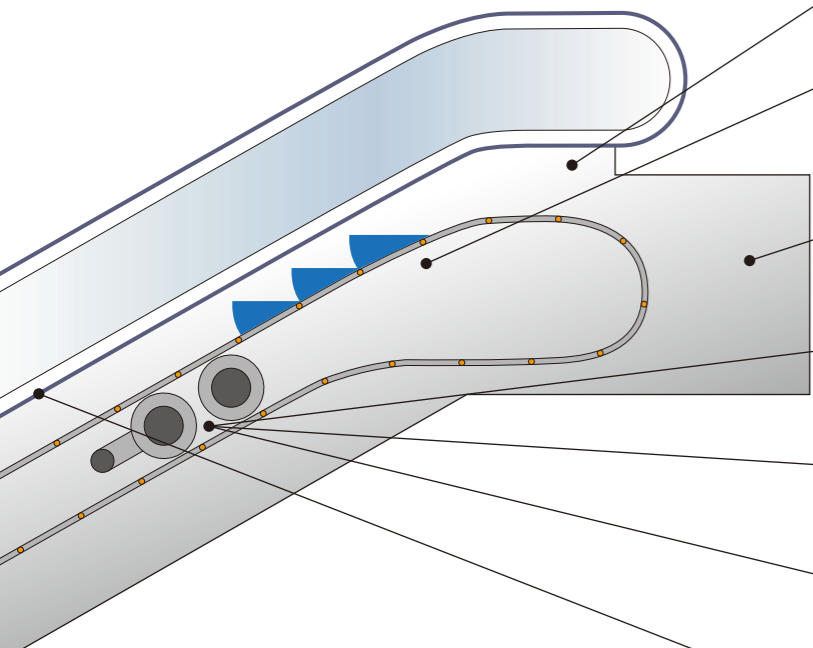

● **Emergency Stop Button (E-STOP)**

A button to immediately stop the escalator in emergency situations.

○ **Step Motion Safety Device (CRS)**

A safety device to stop the escalator when a Step has been dislocated on its riser side due to an object caught between the Steps, or between the Skirt Guard and the Step, or if an abnormality has been observed in the Step motion.

● **Overload Detection Device**

A safety device that stops the escalator if overload has been detected by abnormal current or temperature of the drive motor.

● **Drive Chain Safety Device (DCS)**

A safety device that stops the escalator if the Drive Chain breaks or stretches beyond an allowable limit.

● **Speed Governor (GOV)**

A safety device that stops the escalator if the speed significantly decreases or increases to 120% of the rated speed.

● **Electromagnetic Brake**

A safety device that stops the escalator in the case of power failure, or if any safety device or the Emergency Stop Button has been activated.

○ **Handrail Speed Safety Device (HSS)**

A safety device that stops the escalator if the Moving Handrails fail to synchronize with the Steps due to slippage, loosening or breakage of the Moving Handrails.

○ **Step Level Device (SRS)**

A safety device that stops the escalator if the horizontal level of a Step has dropped.

○ **Skirt Guard Safety Device (SSS)**

A safety device to stop the escalator if a shoe or other item becomes trapped in the gap between the Step and Skirt Guard.

○ **Comb-Step Safety Switch (CSS)**

A safety device that stops the escalator if a foreign object becomes trapped in the gap between the Step and Comb.

● **Handrail Guard Safety Device (HGS)**

1) Inlet Guard
A guard made of soft rubber, which fits over the outside of the Moving Handrail where it enters the Balustrade to keep fingers, hands or foreign objects away from the Moving Handrail opening.

2) Inlet Guard Switch
A safety device that stops escalator when physical contact is made with the inlet.

● **Step Link Safety Device (SLS)**

A safety device that stops the escalator if the Step Link breaks or stretches beyond an allowable limit.

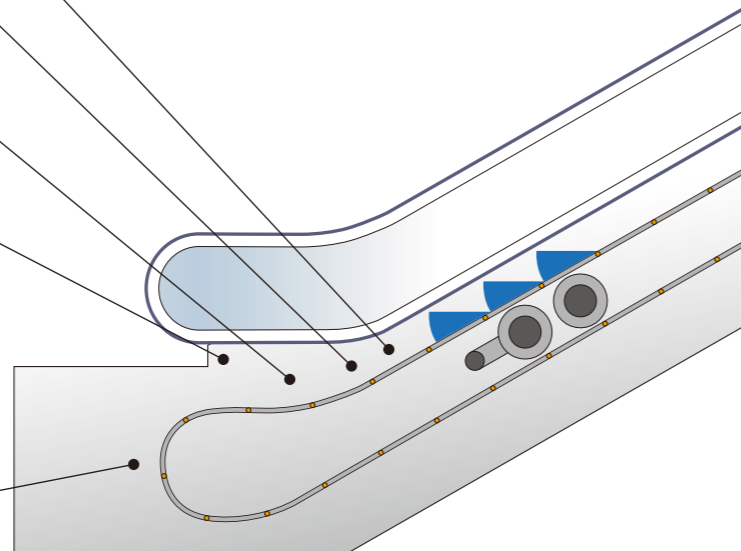

Basic specifications

Item	S600	S1000
Models	ZS / ZL / ZP	
Codes	Japan code	
Power supply	AC 3-phase, 50 or 60Hz	
Lighting power supply	AC single-phase, 50 or 60Hz	
Rated speed	0.5m/sec	
Control system	Standard: AC1 Option: VVVF	
Transport capacity*1 (persons/hr)	4500	9000
Inclination	30°	
Environment	Standard: Indoor Option*2: Semi-outdoor / Outdoor	
Automatic oiler	Standard: None Option: Available	
Min. rise (mm)	7001	
Max. rise (mm)	ZS / ZP: 13000 ZL: 9000 *3	
Step width (mm)	604	1004
Escalator width (mm)	1150	1550
Between Moving Handrails (mm)	840	1240
Between Skirt Guards (mm)	610	1010
Truss width (mm)	1100	1500
Floor opening (mm)	1250	1650

*1: Transport capacity varies depending on actual traffic conditions, so some dimensions and the motor capacity may have to be changed. Please consult your local Mitsubishi Electric sales agent for details if the number of passengers during peak time may equal or exceed the following numbers:

S600: 500 persons per 10 minutes
S1000: 1000 persons per 10 minutes

*2: Please contact your local Mitsubishi Electric sales agent for semi-outdoor and outdoor use. For outdoor use, please refer to "Cautions for outdoor use" on page 13.

*3: Please contact your local Mitsubishi Electric sales agent for rise ranging from 7239mm to 9000mm.

Dimensions

Step width

Type S600 : 604mm
Type S1000 : 1004mm

Rise

Models ZS/ZP : max 13000mm
Model ZL : max 9000mm *3

Inclination

30°

Moving Handrail height

950mm or 1000mm (Option)

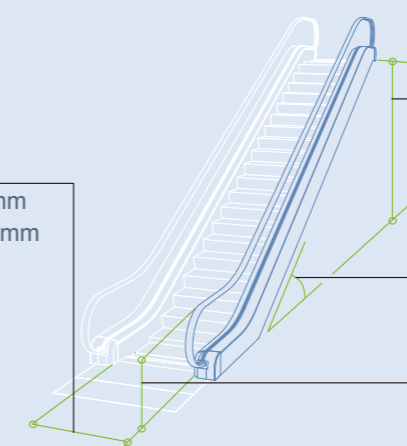

●...Standard ○...Optional N/A...Not applicable

Division	Specification			
		ZS	ZL	ZP
Environment	Indoor		●	
	Semi-outdoor		○	
	Outdoor	○	N/A	○
Control system	AC1		●	
	Inverter (VVVF)		○*1	
	Automatic Operation with Posts (Stationary in stand-by, AC1)		○	
	Automatic Operation with Posts (Slow operation in stand-by, Inverter)		○	
	Post-Free Automatic Operation (Slow operation in stand-by, Inverter)		○	
Safety features	Stop-Buzzer Key Switch		●	
	Anti-Slip Floor Plate		●	
	Step with Anti-Slip Grooves		●	
	Demarcation Line		●	
	Tiered Demarcation Line		●	
	Step Demarcation Lighting		○	
	Comb Light		○	
	Three Horizontal Steps		○	
	Warning System on Moving Handrail Inlet (Inlet Sensor)		○*2	
	Warning System on Outer Deck (Outer Deck Sensor)		○*2	N/A
	Directional Indicator on Handrail Inlet Cap (Handrail Inlet Cap LED Indicator)		○*2	*3
Finish and decorative components	Balustrade	Transparent tempered glass panel	●	N/A
		Under-Handrail Lighting	N/A	●
	Skirt Guard	Stainless steel hairline panel	N/A	●
		Stainless steel hairline		●
		Fluoropolymer Coating		○
	Deck Board	Stainless steel hairline		●
		Skirt Guard Lighting	○*4	N/A
	Step	Aluminum alloy Step Tread		●
		Aluminum alloy Cleat Riser		●
		Yellow Demarcation Line		●
	Floor Plate	Decorative Panel (Embossed stainless steel)		●
		Floor Name		○
		Comb		●
		Extension of Floor Plate		○
Connection of adjacent Floor Plates			○	
Moving Handrail (See page 5 for colors.)		Rubber	No. 0001 (Black)	●
Handrail Inlet Cap	Resin	No. 0502 to 0508	○	
			●	
Others	MeiEye		○	
	Automatic oiler		○	

*1: Please contact your local Mitsubishi Electric sales agent for VVVF control.
 *2: Not applicable to outdoor use.
 *3: Installed only on the right-side Handrail Inlet Cap (when viewed from the boarding and landing areas).
 *4: Not applicable to semi-outdoor and outdoor use.



Escalators in the graphics are based on the Japan Code, with optional Fluoropolymer Coating on Skirt Guard.

(Unit: mm)

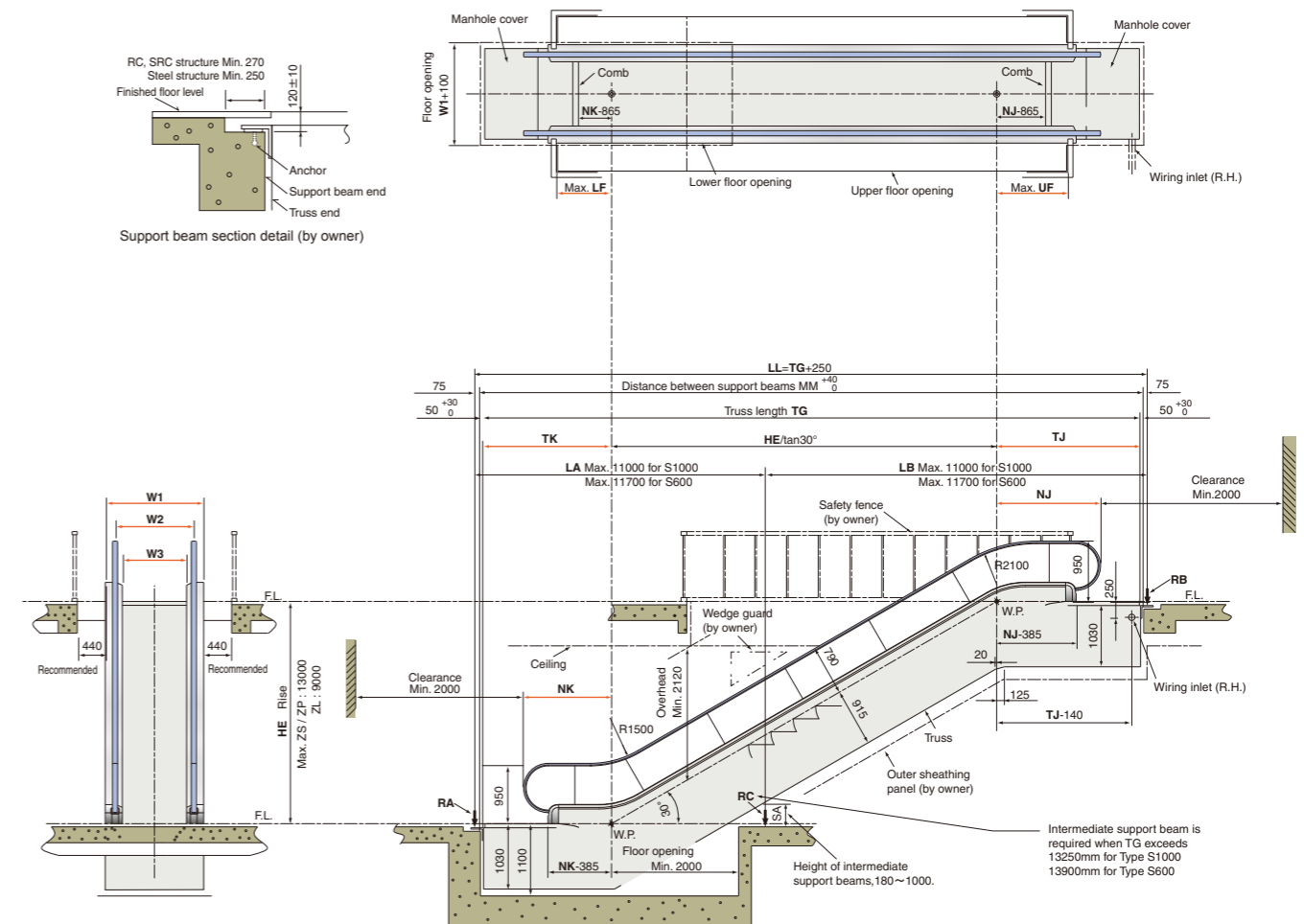

Please contact your local Mitsubishi Electric sales agent for:
 - VVVF control (Please note that TJ may increase from that shown.)
 - Reaction force, RA, RB, RC etc.

■ Standard dimensions

Type	S600	S1000
W1 (Escalator Width)	1150	1550
W2 (Between Moving Handrails)	840	1240
W3 (Between Skirt Guards)	610	1010

Horizontal Steps	LF	UF	NK	NJ	TK	TJ
1.5 Steps(Nominal)*	850	1100	1385	1635	2015	2265
3 Steps	1440	1725	1975	2260	2605	2890

*Please contact your local Mitsubishi Electric sales agent for the actual number of steps.

The Series Z escalator is equipped with various safety devices that provide for safety and reliability.

For EN115 Code

For EN115 Code



For High Rise

Rise (mm): 7001 - 13000

● Standard ○ Optional

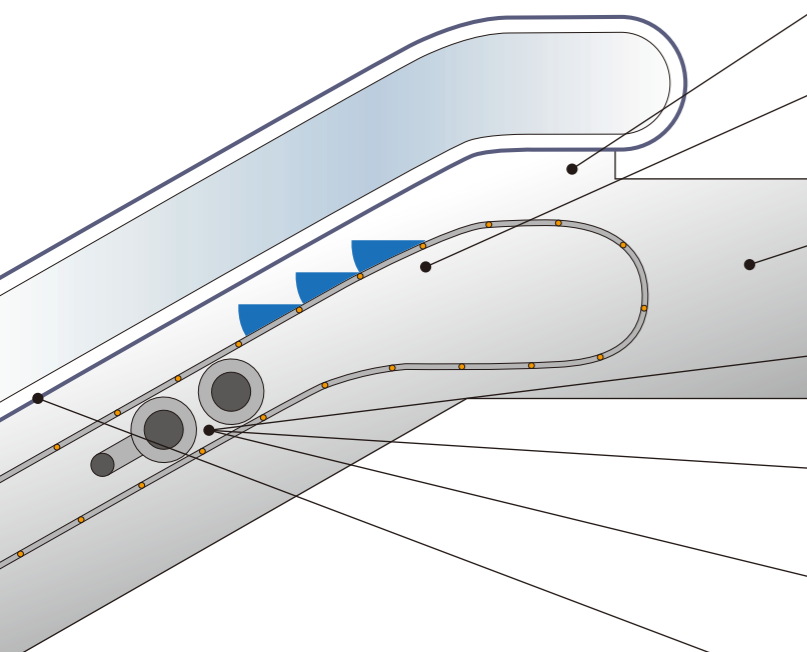

● **Emergency Stop Button (E-STOP)**

A button to immediately stop the escalator in emergency situations.

○ **Step Motion Safety Device (CRS)**

A safety device to stop the escalator when a Step has been dislocated on its riser side due to an object caught between the Steps, or between the Skirt Guard and the Step, or if an abnormality has been observed in the Step motion.

● **Overload Detection Device**

A safety device that stops the escalator if overload has been detected by abnormal current or temperature of the drive motor.

● **Drive Chain Safety Device (DCS)**

A safety device that stops the escalator if the Drive Chain breaks or stretches beyond an allowable limit.

● **Speed Governor (GOV)**

A safety device that stops the escalator if the speed significantly decreases or increases to 120% of the rated speed.

● **Electromagnetic Brake**

A safety device that stops the escalator in the case of power failure, or if any safety device or the Emergency Stop Button has been activated.

○ **Handrail Speed Safety Device (HSS)**

A safety device that stops the escalator if the Moving Handrails fail to synchronize with the Steps due to slippage, loosening or breakage of the Moving Handrails.

● **Auxiliary brake**

A safety device that stops the escalator if the speed exceeds the rated speed, or before the Steps' traveling direction changes due to an abnormality such as breakage of the Drive Chain.

● **Step Level Device (SRS)**

A safety device that stops the escalator if the horizontal level of a Step has dropped.

○ **Skirt Guard Safety Device (SSS)**

A safety device to stop the escalator if a shoe or other item becomes trapped in the gap between the Step and Skirt Guard.

● **Comb-Step Safety Switch (CSS)**

A safety device that stops the escalator if a foreign object becomes trapped in the gap between the Step and Comb.

● **Handrail Guard Safety Device (HGS)**

1) Inlet Guard
A guard made of soft rubber, which fits over the outside of the Moving Handrail where it enters the Balustrade to keep fingers, hands or foreign objects away from the Moving Handrail opening.

2) Inlet Guard Switch
A safety device that stops escalator when physical contact is made with the inlet.

● **Step Link Safety Device (SLS)**

A safety device that stops the escalator if the Step Link breaks or stretches beyond an allowable limit.

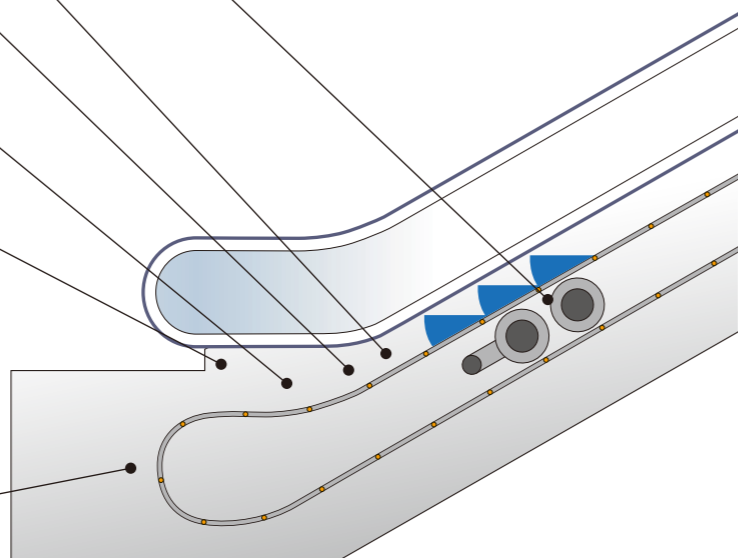

Basic specifications

Item	S600	S1000
Models	ZS / ZL / ZP	
Codes	EN115 code	
Power supply	AC 3-phase, 50 or 60Hz	
Lighting power supply	AC single-phase, 50 or 60Hz	
Rated speed	0.5m/sec	
Control system	Standard: AC1 Option: VVVF	
Transport capacity*1 (persons/hr)	4500	9000
Inclination	30°	
Environment	Standard: Indoor Option*2: Semi-outdoor / Outdoor	
Automatic oiler	Standard: None Option: Available	
Min. rise (mm)	7001	
Max. rise (mm)	ZS / ZP: 13000 ZL: 9000 *3	
Step width (mm)	604	1004
Escalator width (mm)	1150	1550
Between Moving Handrails (mm)	840	1240
Between Skirt Guards (mm)	610	1010
Truss width (mm)	1100	1500
Floor opening (mm)	1250	1650

*1: Transport capacity varies depending on actual traffic conditions, so some dimensions and the motor capacity may have to be changed. Please consult your local Mitsubishi Electric sales agent for details if the number of passengers during peak time may equal or exceed the following numbers:

S600: 500 persons per 10 minutes
S1000: 1000 persons per 10 minutes

*2: Please contact your local Mitsubishi Electric sales agent for semi-outdoor and outdoor use. For outdoor use, please refer to "Cautions for outdoor use" on page 13.

*3: Please contact your local Mitsubishi Electric sales agent for rise ranging from 7239mm to 9000mm.

Dimensions

Step width

Type S600 : 604mm
Type S1000 : 1004mm

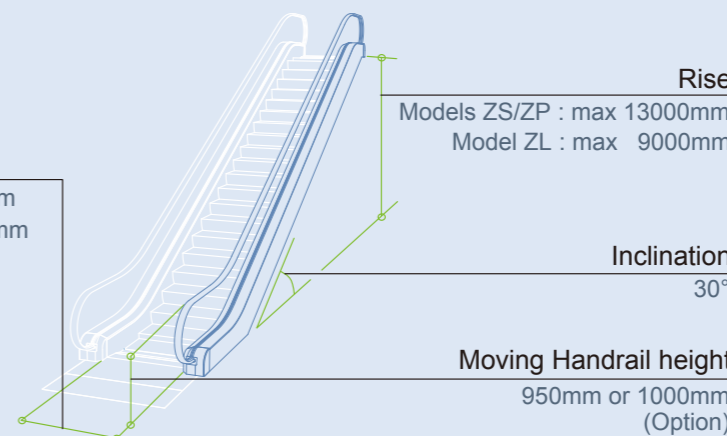

Rise
Models ZS/ZP : max 13000mm
Model ZL : max 9000mm *3

Inclination
30°

Moving Handrail height
950mm or 1000mm (Option)



●...Standard ○...Optional N/A...Not applicable

Division	Specification	ZS	ZL	ZP		
Environment	Indoor		●			
	Semi-outdoor		○			
	Outdoor	○	N/A	○		
Control system	AC1		●			
	Inverter (VVVF)		○*1			
	Automatic Operation with Posts (Stationary in stand-by, AC1)		○			
	Automatic Operation with Posts (Slow operation in stand-by, Inverter)		○			
	Post-Free Automatic Operation (Slow operation in stand-by, Inverter)		○			
Safety features	Stop-Buzzer Key Switch		●			
	Anti-Slip Floor Plate		●			
	Step with Anti-Slip Grooves		●			
	Demarcation Line		●			
	Tiered Demarcation Line		●			
	Step Demarcation Lighting		○			
	Comb Light		○			
	Three Horizontal Steps		●			
	Warning System on Moving Handrail Inlet (Inlet Sensor)		○*2			
	Warning System on Outer Deck (Outer Deck Sensor)		○*2	N/A		
Directional Indicator on Handrail Inlet Cap (Handrail Inlet Cap LED Indicator)		○*2	*3			
Finish and decorative components	Balustrade	Transparent tempered glass panel	●	N/A		
	See page 12 for sections.	Under-Handrail Lighting	N/A	●		
		Stainless steel hairline panel	N/A	●		
	Skirt Guard	Fluoropolymer Coating		●		
		Skirt Guard Lighting	○*4	N/A	○*4	
	Deck Board	Stainless steel hairline		●		
		Step	Aluminum alloy Step Tread	●		
	Floor Plate	Aluminum alloy Cleat Riser		●		
		Yellow Demarcation Line		●		
		Decorative Panel (Embossed stainless steel)	Floor Name		○	
			Comb		●	
		Extension of Floor Plate		○		
Connection of adjacent Floor Plates			○			
Moving Handrail (See page 5 for colors.)		Rubber	No. 0001 (Black)	●		
		No. 0502 to 0508	○			
Handrail Inlet Cap	Resin		●			
Others	MelEye		○			
	Automatic oiler		○			

*1: Please contact your local Mitsubishi Electric sales agent for VVVF control.
 *2: Not applicable to outdoor use.
 *3: Installed only on the right-side Handrail Inlet Cap (when viewed from the boarding and landing areas).
 *4: Not applicable to semi-outdoor and outdoor use.



Escalators in the graphics are based on the Japan Code, with optional Fluoropolymer Coating on Skirt Guard.

(Unit: mm)

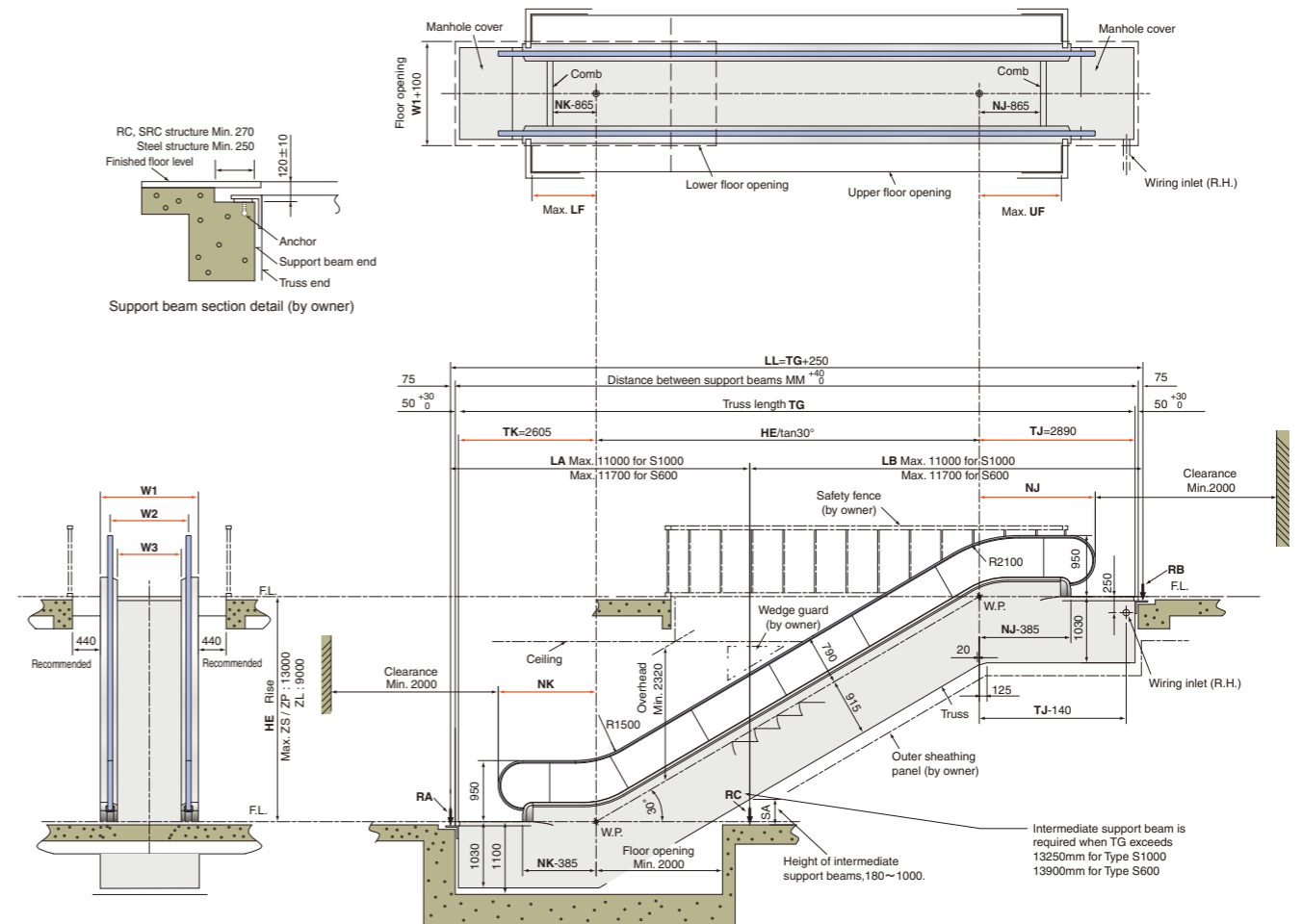

Please contact your local Mitsubishi Electric sales agent for:
 - VVVF control (Please note that TJ may increase from that shown.)
 - Reaction force, RA, RB, RC etc.

■ Standard dimensions

Type	S600	S1000
W1 (Escalator Width)	1150	1550
W2 (Between Moving Handrails)	840	1240
W3 (Between Skirt Guards)	610	1010

Horizontal Steps	LF	UF	NK	NJ
3 Steps	1440	1725	1975	2260

